

## 菱形三叉脚(T:2.0mm)



**白铬**  
**Chrome**  
**STS-8112**  
**H: 13 cm**



**钛金**  
**Gold**  
**STS-8114**  
**H: 13 cm**



**哑黑**  
**Matte Black**  
**STS-8113**  
**H: 13 cm**



**细磨砂黑**  
**STS - 8115 (15 cm)**  
**STS - 8117 (13 cm)**  
**STS - 8118 (13 cm)**  
**Adjustable (可调)**



**枪黑**  
**GunBlack**  
**STS-8116**  
**H: 13 cm**

60PCS/CTN



**STS - 8101 (13 cm)**  
**STS - 8102 (15 cm)**  
**T:1.8 mm**

60 PCS/ CTN



**H:13cm**  
**STS - 8103**  
**(1.8mm)**



**STS - 8107**  
**(10 cm)**  
**STS - 8104**  
**(13 cm)**  
**T:1.8 mm**

60 PCS/CTN



**STS - 8108 (10 cm)**  
**STS - 8105 (13 cm)**  
**STS - 8106 (15 cm)**  
**T:1.6 mm**

100PCS/CTN

## 半圆三叉脚



**STS-4001**  
**T:2.0mm**  
**H:15 cm**  
**STS-4018**  
**T: 2.0 mm**  
**H: 18 cm**  
**Matte Black (哑黑)**



**STS-4002**  
**T:2.0mm**  
**H:15 cm**  
**Gun Black(枪黑)**



**STS-4003**  
**T:2.0mm**  
**H:15 cm**  
**Chrome(铬色)**



**STS-4004**  
**T:2.0mm**  
**H:15 cm**  
**Gold(仿金)**

STS-4001 & 4002 (50PCS/CTN)  
STS-4018 (40PCS/CTN)

STS-4003 (40PCS/CTN) STS-4004 (50PCS/CTN)



**STS - 4008**

**H: 15 cm**

**Colour: Gun Black**

**T: 2.0mm**

**(40PCS/CTN)**



**STS - 4009**

**H: 15 cm**

**Colour: Matte Black**

**T: 2.3mm**

**40PCS/CTN**



**STS - 9901**

**H: 15 cm**

**T: 1.5 mm**

**Matte Black (哑黑)**

**STS - 9902**

**H: 15 cm**

**T: 1.5 mm**

**Gun Black (枪黑)**

**STS-9901 - 40PCS/CTN**

**STS-9902 - 60PCS/CTN**



**Top Ø: 33 mm**  
**Bottom Ø: 20 mm**

**STS - 7024 (H: 15 cm)**

**STS - 7025 (H: 25 cm)**

**STS - 7026 (H: 30 cm)**

**STS - 7027 (H: 35 cm)**

**Colour: Matte Black**

**7024 & 7025 & 7026 (60PCS/CTN)**  
**7027 (40PCS/CTN)**



**Top Ø: 33 mm**  
**Bottom Ø: 20 mm**

**STS - 7029 (H: 15 cm)**

**STS - 7030 (H: 25 cm)**

**STS - 7031 (H: 30 cm)**

**STS - 7032 (H: 20 cm)**

**STS - 7033 (H: 35 cm)**

**Colour: Gold**

**7029 & 7030 & 7031 & 7032 (60PCS/CTN)**  
**7033 (40PCS/CTN)**



**Top Ø: 33 mm**  
**Bottom Ø: 20 mm**

**STS - 7085 (H: 13 cm)**

**STS - 7086 (H: 17 cm)**

**STS - 7087 (H: 20 cm)**

**STS - 7088 (H: 35 cm)**

**斜锥脚 (黑配金)**

**7085 & 7086 & 7087 (60 PCS/ CTN)**  
**7088 (40PCS/CTN)**



**Colour: Beige**

**STS - 9112 (H: 12 cm)**

**STS - 9115 (H: 15 cm)**

**STS - 9120 (H: 20 cm)**

**Top Ø: 54mm**

**Bottom Ø: 42mm**

**9112 & 9115 (60PCS/CTN)**  
**9120 (50PCS/CTN)**



**STS - 8006**

**Ø: 50 mm**

**L: 180 mm**

**Colour:**

**STS - 8007**

**Chrome**

**Ø: 40 mm**

**L: 220 mm**

**(60PCS/CTN)**



**STS - 9112**

**H: 12 cm**

**Top Ø: 54 mm**

**Bottom Ø: 42 mm**

**STS - 9115**

**H: 15 cm**

**Top Ø: 59 mm**

**Bottom Ø: 42 mm**

**Colour: Brown**

**STS - 7115**

**H: 15 cm**

**Top Ø: 60 mm**

**Bottom Ø: 43 mm**

**Colour: Brown**

**(60PCS/CTN)**



**STS-A901**  
 H: 100 mm  
 T: 4.0 mm  
 W: 38 mm  
 L: 22 cm  
 Colour: Chrome

40 PCS/ CTN



**STS - A903**  
 H: 12 cm  
 L: 18 cm  
 W: 5 cm  
 T: 4.0 mm

30 PCS/ CTN



**STS - A906**  
 H: 12 cm  
 L: 21 cm  
 W: 3 cm  
 T: 4.0mm  
 Colour: Chrome

40 PCS/ CTN



**STS - A905**  
 H: 100mm  
 T: 4.0 mm  
 W: 40 mm  
 L: 21 cm  
 Colour: Matte Black

40 PCS/ CTN



**STS-A904**  
 H: 12 cm  
 L: 17.5cm  
 W: 5 cm  
 T: 4.5 mm

30 PCS/ CTN



**STS-A902**  
 H: 12 cm  
 L: 21 cm  
 W: 3cm  
 T: 4.0 mm  
 Colour: Matte Black

40 PCS/ CTN



**STS - 8043**   **STS - 8044**  
 H: 15 cm   H: 18 cm  
 T: 2.5 mm   T: 3.0 mm  
 Colour: Gun Black

40 PCS/ CTN



**STS-8045**   **STS-8046**  
 H:15 cm   H:15 cm  
 Gun Black   Gold

60 PCS/ CTN

**STS-6049**  
**H: 15 cm**  
**Colour: Gun Black**



40 PCS/ CTN



**STS-6050**  
**H: 12cm**  
**Colour: Gun Black**

60 PCS/ CTN



**STS -6053**  
**H: 17.5 cm**  
**T: 2.0 mm**  
**Colour: Matte Black**

60 PCS/ CTN



**STS-8073**  
**H: 15cm**  
**Colour: Matte Black**

8073-40PCS/CTN



**STS-8075**  
**H:19cm**  
**Colour: Grey**

60 PCS/ CTN



**STS - 8036**  
**H: 12mm**  
**T: 2.5 mm**  
**Colour: Chrome**

50 PCS/ CTN



**STS - 8040 (15 cm)**  
**STS - 8041 (13 cm)**

**T: 2.5 mm**  
**Colour: Matte Black**

60 PCS/ CTN





100PCS/CTN



STS - 7512 200 PCS/ CTN



STS - 7515 200PCS/CTN



150PCS/CTN



15PCS/CTN



4PCS/CTN



30PCS/CTN



4PCS/CTN



**STS - 9034**  
**H: 15cm**

35PCS/CTN



**STS - 9038**  
**H: 15 cm**  
**T: 2.5 mm**  
**Ø: 25 mm**

40PCS/CTN



**STS - 9039**  
**H: 14.5cm**

60PCS/CTN



**STS - 6056**  
**H: 7 cm**

120PCS/CTN



**STS - 8070**  
**H: 15cm**  
**Colour: Matte Black**

40PCS/CTN



**STS - 8071**  
**H: 15cm**  
**Colour: Gun Black**

40PCS/CTN



**STS - 8022**  
**H: 9.5 cm**  
**T: 0.80 mm**

120 PCS/ CTN



**STS - 3226**  
**H: 12 cm**      **Colour: Chrome**  
**T: 1.8 mm**

60 PCS/ CTN



**STS - 8064**  
**H: 15 cm**  
**T: 2.5 mm**  
**Colour: Chrome**

**STS - 8065**  
**H: 15 cm**  
**T: 2.5 mm**  
**Colour: Matte Black**



(50PCS/CTN)



**STS - 8076**  
**H: 18 mm**      **Colour: Matte Black**  
**T: 2.5 mm**

60 PCS/ CTN



**STS - 8056**  
**H: 14 cm**  
**T: 1.2 mm**  
**Colour: Chrome**

60 PCS/ CTN



**STS - 8133**  
**H: 13 cm**  
**T: 5.8 mm**  
**Colour: Chrome**

40 PCS/ CTN



**STS-6054**  
**H: 55mm**  
**Colour: Chrome**

100 PCS/ CTN



1 SET/ CTN



10 SET/ CTN







**STS-D422**

- 材质 / Material: Iron (铁)
- 表面处理 / Finish: 镀锌、镀铬  
White Zinc Plated、Chrome Plated

20 PAIR/CTN



**STS-D423 ( 橡拔铰螺杆 )**

- 材质 / Material: Iron (铁)
- 表面处理 / Finish: 镀锌、镀铬  
White Zinc Plated、Chrome Plated

25 PAIR / CTN



**STS-D404  
Head Gearing  
6档头枕铰链**

25 PAIR / CTN



**STS - D428  
弯月头铰**

15 SET / CTN



**STS - D429**

15 SET / CTN



**STS - D430  
弯月头铰**

15 SET / CTN



**STS-D427  
大耳朵升降**

25 PAIR / CTN



**STS-A419  
(方片雨伞)  
H: 170mm**

200 PCS/ CTN



**STS -  
139**

15 SET / CTN

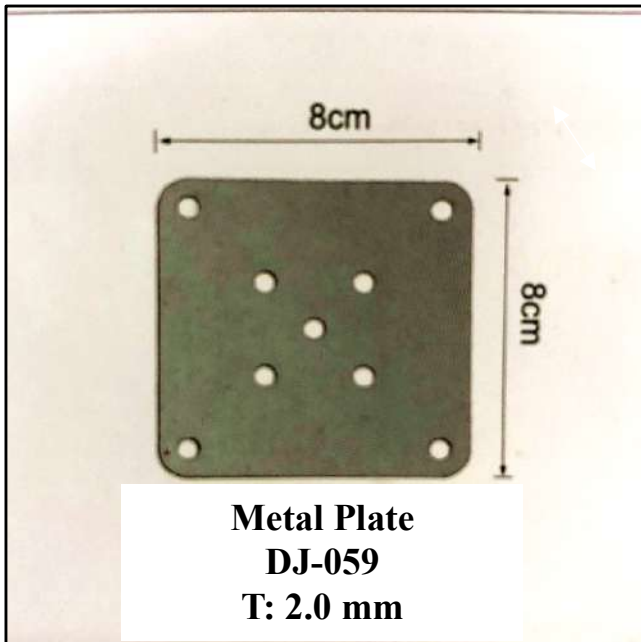

400 PCS/ CTN

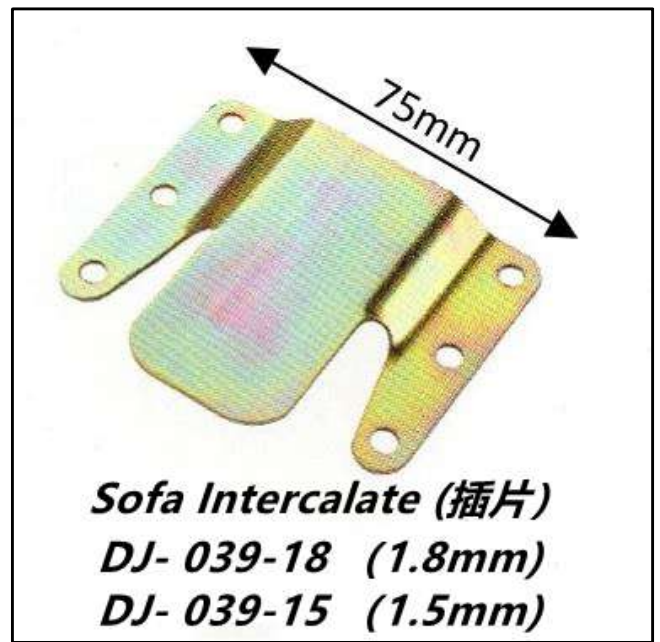

500 PCS/ CTN

Thickness Available: 1.8mm & 1.5mm

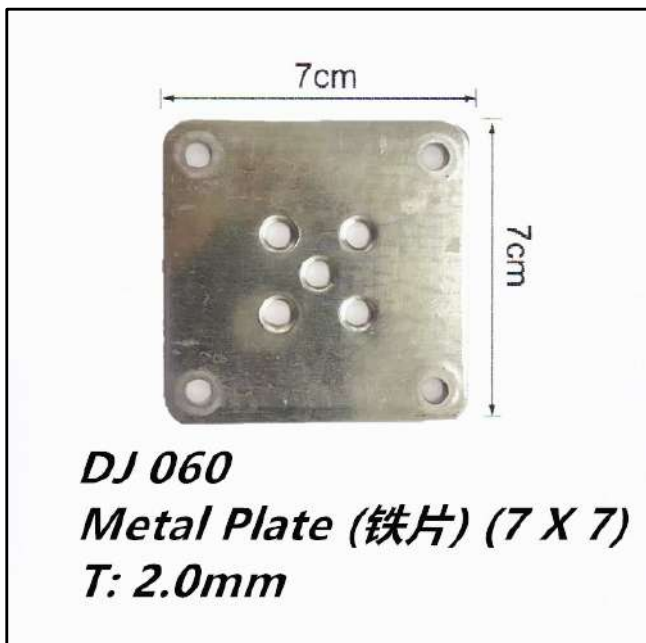

500 PCS/ CTN



500 PCS/ CTN



200 SET / CTN

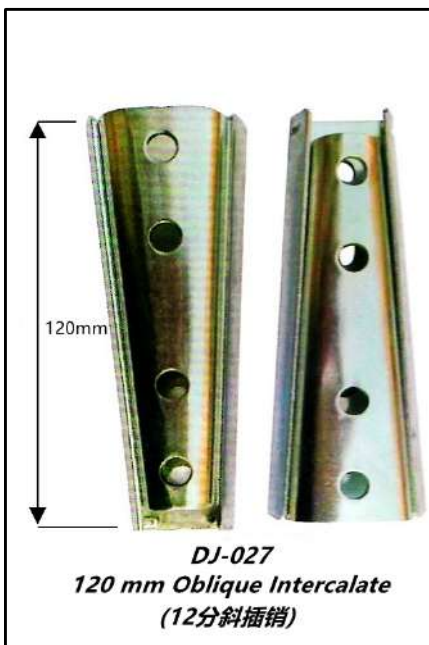

**DJ-027**  
120 mm Oblique Intercalate  
(12分斜插销)

200 SET/ CTN

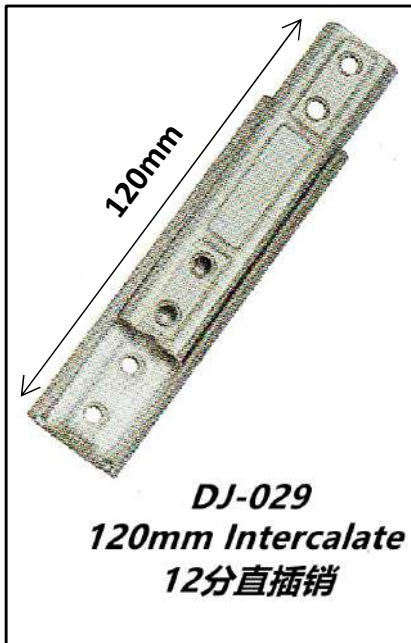

**DJ-029**  
120mm Intercalate  
12分直插销

(200 SET/CTN)



**STS-137**  
Divan Hinge  
床头铰

20 SET / CTN



**DJ-093**  
Watch Hinge  
手表铰链  
Ø = 40 mm

50 SET / CTN



**DJ - 094**  
Sofa Hinge (4 gear)  
小圆短支拆装4档

30 SET / CTN



**DJ-095**  
Sofa Hinge (3 gear)  
(Auto Rebound)  
3 档 (自动回弹)

25 SET / CTN



**STS-138**  
Petal Hinge  
花瓣铰

10 SET / CTN



**DJ-325**  
Table Hinge  
茶几铰

12 SET / CTN





SOFA PUSH BACK (10PCS/CTN)

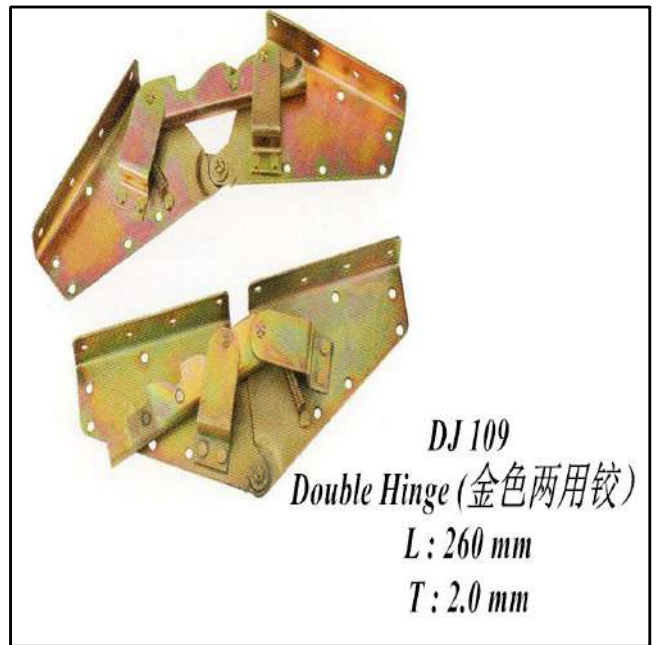

25 PAIR / CTN



120PCS/CTN

200PCS/CTN

100PCS/CTN



100PCS / CTN



200PCS / CTN





**NO: 102**  
**H: 160 cm**  
**Top Ø: 55 mm**  
**Bottom Ø: 40 mm**  
**Oblique Leg**  
**(Beech)**



**NO: 102**  
**H: 160 cm**  
**Top Ø: 55 mm**  
**Bottom Ø: 40 mm**  
**Oblique Leg**  
**(Black)**

**90 PCS/PACK**



**NO: 98**  
**H: 150 mm**  
**Top Ø: 60 mm**  
**Bottom Ø: 30 mm**  
**6" Cone Leg**  
**(Beech)**



**NO: 98**  
**H: 150 mm**  
**Top Ø: 60 mm**  
**Bottom Ø: 30 mm**  
**6" Cone Leg**  
**(Black)**

**110 PCS/PACK**



**NO: 81 - Support Leg**  
**H: 25.3 mm**  
**L: 71.5 mm**



**Plastic Leg Stopper**  
**Ø: 30 mm**  
**H: 8 mm**

**Support Leg - 400 PCS/PACK**  
**Stopper - 240 PCS/PACK**





**No. 99- 6" Cone Leg (Beech)**  
**with hanger bolt M8.**  
**(H150mm X 60mmØ X 30mmØ)**

**No. 99- 6" Cone Leg (Black)**  
**with hanger bolt M8**  
**(H150mm X 60mmØ X 30mmØ)**

**120 PCS/PACK**

**120 PCS/PACK**



**White Furniture**  
**Glide Nail**  
**(白脚钉)**  
**Ø 20mm X L15mm**

**20000 PCS/CTN**



**No: 109**  
**H:16 cm**  
**Plastic Cabinet Leg**  
**Black**

**100 PCS/PACK**



**No: 110**  
**H:16 cm**  
**Plastic Cabinet Leg**  
**White**

**100 PCS/PACK**



**JCJ-001**

**50 mm (H) X 160 mm**

**120 PCS/PACK**



**JCJ - 002**

*(Wooden Surface)  
Plastic Leg*

**65 mm (H) X 128 mm**

**100 PCS/PACK**



**JCJ-003**

**L: 100 mm  
W: 35 mm  
H: 50mm**

**120 PCS/PACK**



**JCJ-010  
Plastic Leg  
L: 60mm  
W: 60mm  
H: 100mm**

**130 PCS/PACK**



**JCJ-004  
Plastic Leg  
L: 150mm  
W: 38mm  
H: 50 mm**

**150 PCS/PACK**



**JCJ-005  
(Wooden Surface)  
Plastic Leg  
H: 69mm  
W: 68mm  
L: 142mm**

**60 PCS/PACK**



**1/2 " SOFA LEG (PLASTICS)**  
**Ø 1.7" X H 1/2"**

**1800 PCS/PACK**



**1 " Plastic Sofa Leg**  
**Diameter: 1.7 "**

**1000 PCS/PACK**



**2 " PLASTIC SOFA LEG**  
**DIAMETER: 2.5 "**

**300 PCS/PACK**



**2.5" SOFA PLASTIC LEG**  
**(WOODEN SURFACE)**  
**H: 63 mm**  
**Diameter: 2.5"**

**250 PCS/PACK**



**3" PLASTICS SOFA LEG**  
**H: 75 mm**  
**L: 86 mm**  
**W: 86 mm**

**90 PCS/PACK**



**3.5 " PLASTIC SOFA LEG**  
**H: 89 mm**  
**L: 85 mm**  
**W: 85 mm**

**80 PCS/PACK**



**4" PLASTICS SOFA LEG**  
**DIAMETER: 80 mm**

**80 PCS/PACK**





**NO: 82550A**  
H: 12 cm

**NO: 82560A**  
H: 15CM

Ø: 55mm

80 mm X 80 mm

82550A-120 PCS/CTN  
82560A - 120PCS / CTN



**NO: 82580A**  
H: 20 cm  
Ø: 55 mm

80 mm X 80 mm

180 PCS / CTN



**NO: 82561A**  
H: 15 cm

**Colour:**  
**Dark Brown**

Top Ø: 55mm  
Bottom Ø: 40 mm

120 PCS / CTN



**NO:**  
**92550A**  
H: 12 CM

**NO:**  
**92560A**  
H: 15CM

Ø: 55 mm

80 mm X 80 mm

92550A - 120PCS/CTN  
92560A - 120 PCS / CTN



**NO: 92561A**

H: 15 cm  
Top Ø:  
53mm  
Bottom Ø:  
38mm

**Colour:**  
**Dark Brown**

80mm X 80mm

120 PCS / CTN



**Wood Leg**

**No: 71744**

**No: 71745**

H: 17"

H: 17"

Top:  
40 mm X  
40 mm

Top:  
40 mm X  
50 mm

78 PCS/CTN



**NO: 66025**    **NO: 66020**  
H: 7"            H: 8"  
Top:  
32 mm X 69 mm

66020 60 PCS / CTN  
66025 120PCS/CTN



**NO: 66025**    **NO: 66024**  
**Tiger Bend**    **Tiger Leg**  
**Leg**            H: 8"  
H: 7"  
Top: 32 mm X 69 mm

66024-60 PCS / CTN



**NO: 66018**  
Top: 60 mm X 60mm  
Bottom: 32mm X 32mm  
H: 18 cm

180 PCS / CTN





**NO: 82080**

H: 18cm  
Top Ø: 50mm  
Bottom Ø: 38mm

**NO: 92080**

H: 18cm  
Top Ø: 50mm  
Bottom Ø: 38mm



Ø :  
60mm

NO: 56050 > 12 cm  
NO: 56060 > 15 cm

56050:216 PCS / CTN  
56060: 150 PCS / CTN



NO:59060 NO:59061  
M9 screw

H: 15cm  
Ø : 70mm

100 PCS / CTN



NO: 58050  
H:12 cm  
Colour: Reddish Brown

140 PCS / CTN



NO:56040  
H: 10 cm  
Ø : 60mm

168 PCS / CTN



NO:58040  
H: 10 cm  
Ø : 63mm  
Screw: M9

100 PCS / CTN



NO:58040A  
H: 10 cm  
Ø : 65mm

120 PCS / CTN

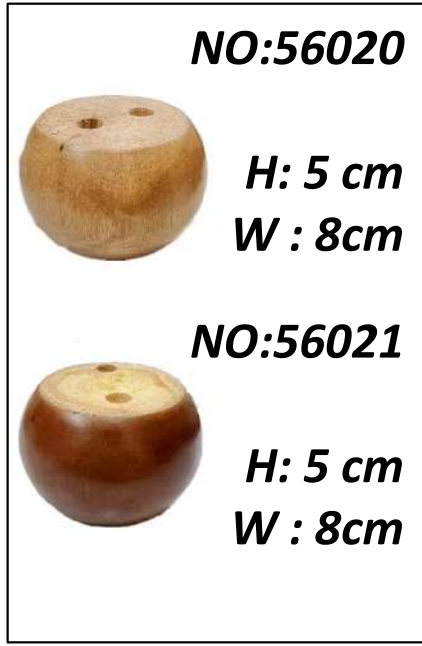

NO:56020

H: 5 cm  
W : 8cm

NO:56021

H: 5 cm  
W : 8cm

56020-216 PCS / CTN  
56021- 252PCS/CTN



NO: 92055

H: 14 cm  
ø: 38 mm  
Screw: M9



**Gem Flower  
(Crystal Glass) 宝石花**

**No: 2008 => 20 mm  
No: 2508 => 25 mm**



**Satellite  
(Crystal Glass) 卫星**

**No: 1801 => 18 mm  
No: 2001 => 20 mm  
No: 2501 => 25 mm**



**Satellite (Blue)  
卫星 (蓝色)**

**No: 2005 => 20 mm  
No: 2505 => 25 mm**



**Satellite (Purple)  
卫星 (紫色)**

**No: 2506 => 25 mm**



**Satellite (Red)  
卫星(大红)**

**No: 2507 => 25 mm**

**Remark for Button Diamond:**  
• For 18 mm (1392 PCS/BOX)  
• For 20 mm (1000 PCS/BOX)  
• For 25 mm (550 PCS/BOX)



**0.8mm Flat Trim  
Strip(平面装饰条)**

**DJ-301 W: 21mm  
DJ-302 W:40mm**

**1ROLL X 100M**



**1" PVC Edge  
Banding Gold  
1 roll x 50 m**

**1CTN X 4 ROLL**

**Rattan Screw**

**(Black)**

**Ø : 4.2mm**



**Product :**

- 7 X 25 mm (25000 pcs/ ctn)
- 7 X 38 mm (15000 pcs/ ctn)
- 7 X 50 mm (10000 pcs/ ctn)
- 7 X 63 mm (6000 pcs/ ctn)
- 8 X 75 mm (4000 pcs/ ctn)



Crown: 11.10mm

Width: 0.7mm

Thickness: 0.5mm

Application: Uphlostry works, Drawers, Cabinets, Paper board, Carpet laying, Window Shade

**Product :**

- 1007F
- 1010F

**Colour:**

- Silver
- Black



**Product :**

- 425K
- 432K
- 438K

Crown: 5.8mm

Width: 1.05mm

Thickness:

1.26mm

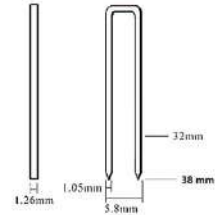

Application: Uphlostry works, Drawers, Cabinets, Paper board, Carpet laying, Window Shade

**40 BOX X 5000 PCS/CTN**

**10 BOX X 5000 PCS/CTN**

**CHIPBOARD SCREW**



**Product :**

- 4 X 32 mm (20000 pcs/ ctn)
- 4 X 38mm (15000 pcs/ ctn)
- 4 X 50 mm (8000 pcs/ ctn)
- 4 X 65 mm (7000 pcs/ ctn)

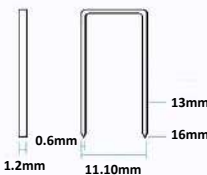
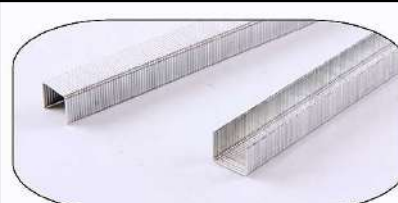

Crown: 11.10mm

Width: 1.2mm

Thickness: 0.6mm

Application: Uphlostry works, Drawers, Cabinets, Paper board, Carpet laying, Window Shade

**Product :**

- 1006J
- 1013J
- 1016J
- 1022J

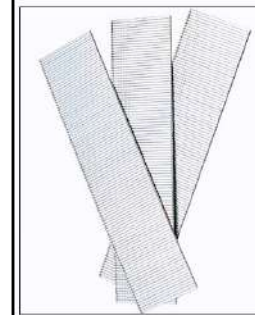

**Product :**

- F25
- F30

Crown: 1.9mm

Width: 1.05mm

Thickness: 1.26mm

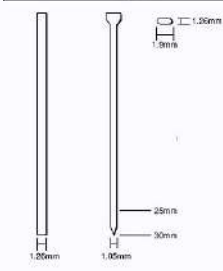

Application: Carpentry, Baseboards, Crown Molding, Pallet, Furniture Trim

**1006J- 40 BOX X 5000PCS/CTN**

**1CTN X 20 BOX**

**1013J & 1016J - 20 BOX X 5000 PCS/CTN**



**Hexagon Head Self Drilling Screw (TD-HO)**

- Ø 5.5 X 38mm (4000PCS/CTN)
- Ø 5.5 X 50mm (3000PCS/CTN)
- Ø 5.5 X 63mm (2000PCS/CTN)
- Ø 4.8 X 75mm (2000PCS/CTN)

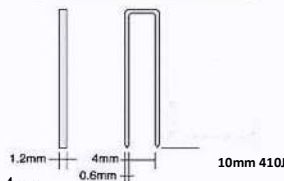
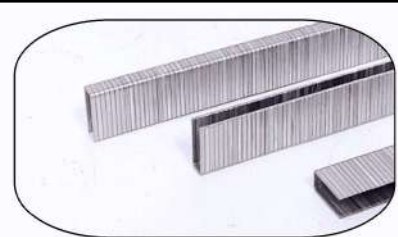

Crown: 4mm

Width: 1.2mm

Thickness: 0.6mm

Application: Uphlostry works, Drawers, Cabinets, Paper board, Carpet laying, Window Shade

**Product :**

- 410J
- 422J

**410J- 40 BOX X 5000PCS/CTN**

**422J - 20 BOX X 5000 PCS/CTN**









**Air Nailer / Stapler**

**1010F**

**\*HY\***



**Firing Pin & Bumper**



**Air Nailer / Stapler**

**440K**

**\*HY\***

**Stapler Length:  
19mm- 40mm**



**Air Nailer/ Stapler**

**F30**

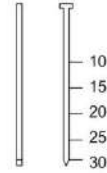

(mm)



**Air Nailer / Stapler**

**1013J**

**\*HY\***

**Stapler Length:  
4mm- 13mm**



**C -7E**

**C Hook Ring Air Stool  
(C 型枪)**



**M66 AIR RACKER  
(M66 夹码枪)**



**Air Nailer/ Stapler**

**1022J**

**\*HY\***

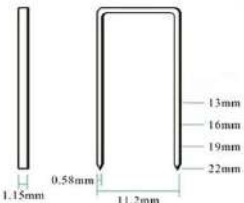

**C HOOK RING  
(STOOL)**

**1CTN X 4BOX X 10000PCS**



**M66  
Mattress Clip  
夹码钉**

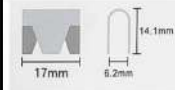

CROWN	INSIDE WIDTH	HEIGHT
17 mm	6.2mm	14.1mm

**APPLICATION:**  
Spring mattress manufacture,  
Car seat manufacture, Pet cage  
manufacture, Spring Sofa manufacture.

**150 ROPE X 40PCS/ BOX**



DJ 081  
ZigZag Spring (卷簧)

3.0 mm - 4 kg  
3.6 mm - 5 kg  
3.8 mm - 6 kg  
4.0 mm - 7 kg

3.0 mm - 8 ROLL/PACK    3.8 mm - 5 ROLL/PACK  
3.6 mm - 6 ROLL/PACK    4.0 mm - 5 ROLL/PACK



DJ 082  
Super Flat  
Zig Zag Spring  
(拱簧)

Thickness: 3.8mm

41 cm X 10    57 cm X 14  
43 cm X 11    61 cm X 15  
48 cm X 12    65 cm X 16  
51 cm X 13

300 PCS /PACK



OKE CLIP 2000 PCS /ROLL



Paper Cover Wire (纸包线)  
T: 2.0 mm

500 M /PACK



OKE CLIP (BY PIECE)

2000 PCS/CTN



Sofa Webbing  
橡筋带

#150, #250, #350, #350A, #370, #470  
(1CTN X 10R X 50M)





**DJ-045**  
**P" RUBBER CLIP**  
**L:46 mm**  
**H:15 mm**  
**W:18mm**

(1 CTN X 1400PCS)

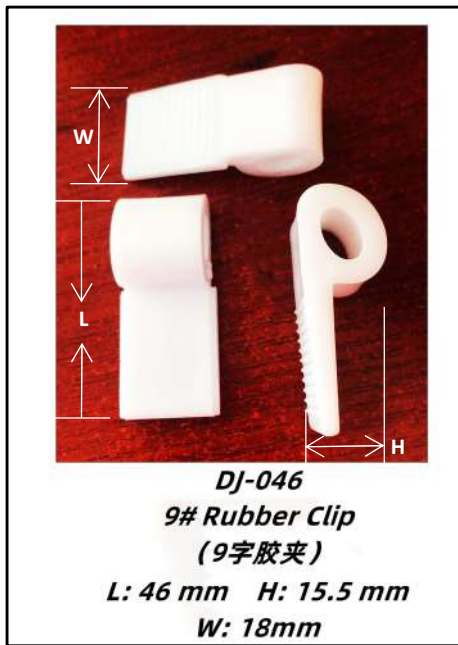

**DJ-046**  
**9# Rubber Clip**  
**(9字胶夹)**  
**L: 46 mm H: 15.5 mm**  
**W: 18mm**

(1 CTN X 1400PCS)



弹簧切割折弯机

ZIP ZAG SPRING BEND AND CUT MACHINE



**DJ -126 -1**  
**W: 20mm**  
**Spring Clip 4 Holes**

(3000PCS/CTN)



**A 022**  
**拉簧器**  
**Spring Strecher**



**DJ-032**  
**围边条(Sofa Edge Strip)**



**◆ BONDED THREAD 邦迪线**



150D/3, 210D/3, 300D/3, 420D/3  
Including bonded nylon thread and bonded polyester thread, high tension, high resistance to abrasion, excellent seam strength and appearance.  
包括尼龙邦迪线和涤纶邦迪线, 具有拉力高、耐磨性能好、缩水率小, 弹性适度缝迹平整等优点

**Strongbow Nylon 6.6 – 40/3, 20/3, 10/3, 8/3**  
**Strongbow Polyester – 30/3**  
**(10 PCS / BOX)**



**FLYFISH NYLON THREAD 210D/3 100GRM**  
**12 PCS / BOX**



**POLYESTER SIDE THREAD 400GRM**  
**(车边线) (10 PCS / BOX)**



**【拉扣线】**  
**BUTTON THREAD 500GRM**  
**1 CTN X 63 PCS**



**Button Thread (80D/4) 900 GRM**

**1 CTN X24 PCS**



**Leather Pen- Silver (Metal)**

**Leather Pen- Silver (Plastic)**

**Plastic- 50 pcs/box**  
**Metal- 120pcs/box**

**100 mm Pull Ring Handle (拉环)**



**DJ - 201**  
T: 16mm  
Gold



**DJ-207**  
T: 16mm  
Silver

100PCS/CTN

**100 mm Pull Ring Handle (拉环)**



**DJ - 203**  
T: 12mm  
Gold



**DJ - 204**  
T: 12mm  
Silver

120PCS/CTN

**70 mm Pull Ring Handle (拉环)**



**DJ - 205**  
T: 12mm  
Gold



**DJ - 206**  
T: 12mm  
Silver

200PCS/CTN



*\*All Dimension is in mm*

**DJ-477 Square Buckle (方形拉扣)**

DJ - 477 - 03  
DJ - 477 - 04  
DJ - 477 - 02  
DJ - 477 - 01

DJ - 477 - 01 => Brushed Gold (金色拉丝)  
DJ - 477 - 02 => Rose Gold (玫瑰金色)  
DJ - 477 - 03 => Chrome (铬色)  
DJ - 477 - 04 => Gun Black (枪黑色)

100PCS/PACK

**椭圆形扣(Oval Buckle) (10mm X 35mm)**



**DJ-478-01**  
Gold  
金色



**DJ-478-04**  
Gun Black  
枪黑色

100PCS/PACK

**子弹扣(Bullet Buckle) (9cm)**



**DJ-479-01 Gold 金色**



**DJ-479-04 Gun Black 枪黑色**

100PCS/PACK





*Italy Nail String - 16 mm Red ( With Nail ) - No : 1601*



*Italy Nail String - 16 mm Green ( With Nail ) - No : 1602*



*Italy Nail String - 16 mm Gold ( With Nail ) - No : 1604*



*Italy Nail String - 16 mm Cat Eye ( With Nail ) - No : 1608*

1601, 1602, 1608 => 200 PCS / CTN

1604 => 150PCS/CTN



**Bubble Nail Air Tool**  
气动钉枪

送



置钉板 + 润滑油 + 内六角



**Bubble Nail Air Tool Nozzle**  
气动钉枪 枪嘴

Size Available: 11mm, 16mm, 19mm





***Italy Nail String - 9.5mm Normal - No : 0901***



***Italy Nail String - 9.5mm Normal ( With Nail ) - No : 0902***



***Italy Nail String - 9.5mm Import - No : 1113***



***Italy Nail String - 11mm Import - No : 1109***



***Italy Nail String - 11mm Import ( With Nail ) - No : 1110***



***Italy Nail String - 11mm Design - No : 1101***



***Italy Nail String - 11mm Design ( With Nail ) - No : 1102***



***Italy Nail String - 11mm Gold - No : 1103***



***Italy Nail String - 11mm Gold ( With Nail ) - No : 1104***



***Italy Nail String - 11mm Silver - No : 1105***



***Italy Nail String - 11mm Silver ( With Nail ) - No : 1106***



***Italy Nail String - 11mm Cat Eye - No : 1107***



***Italy Nail String - 11mm Cat Eye ( With Nail ) - No : 1108***

9.5 mm (200-300 PCS/CTN)

11 mm (200 PCS/CTN)



Bubble Nail / 泡钉



**Ancient** 11mm X L17mm - No: 1148  
**Green** 16mm X L20mm - No: 1648  
**青古** 19mm X L23mm - No: 1948  
 22mm X L23mm - No: 2248

Bubble Nail / 泡钉



**Silver** 11mm X L17mm - No: 1147  
 16mm X L20mm - No: 1647  
**白叻** 19mm X L23mm - No: 1947  
 22mm X L23mm - No: 2247

Bubble Nail / 泡钉



**Ancient** 11mm X L17mm - No: 1149  
**Red** 16mm X L20mm - No: 1649  
**红古** 19mm X L23mm - No: 1949  
 22mm X L23mm - No: 2249

Bubble Nail / 泡钉



**Gold** 11mm X L17mm - No: 1150  
**仿金** 16mm X L20mm - No: 1650  
 19mm X L23mm - No: 1950  
 22mm X L23mm - No: 2250

Bubble Nail / 泡钉



**Cat Eye** 11mm X L17mm - No: 1135  
**猫眼** 16mm X L20mm - No: 1635  
 19mm X L23mm - No: 1935

Bubble Nail / 泡钉



**Flower Ancient** 11mm X L17mm - No: 1138  
**花古**

Remark:

- For 11 mm (1CTN X 50 PACK X 500 PCS)
- For 16 mm (1CTN X 30 PACK X 300 PCS)
- For 19 mm (1CTN X 30 PACK X 200 PCS)
- For 22mm ( 1 PACK X 200PCS)



**Products specification :**

Composition: 100% polypropylene

Technique: spun bond

Gram Weight: 12-300gsm

Width: 0.2-3.2m

Design: square/oval

Color: various colors for your option, customizing available



**PP SPONGE NON WOVEN**

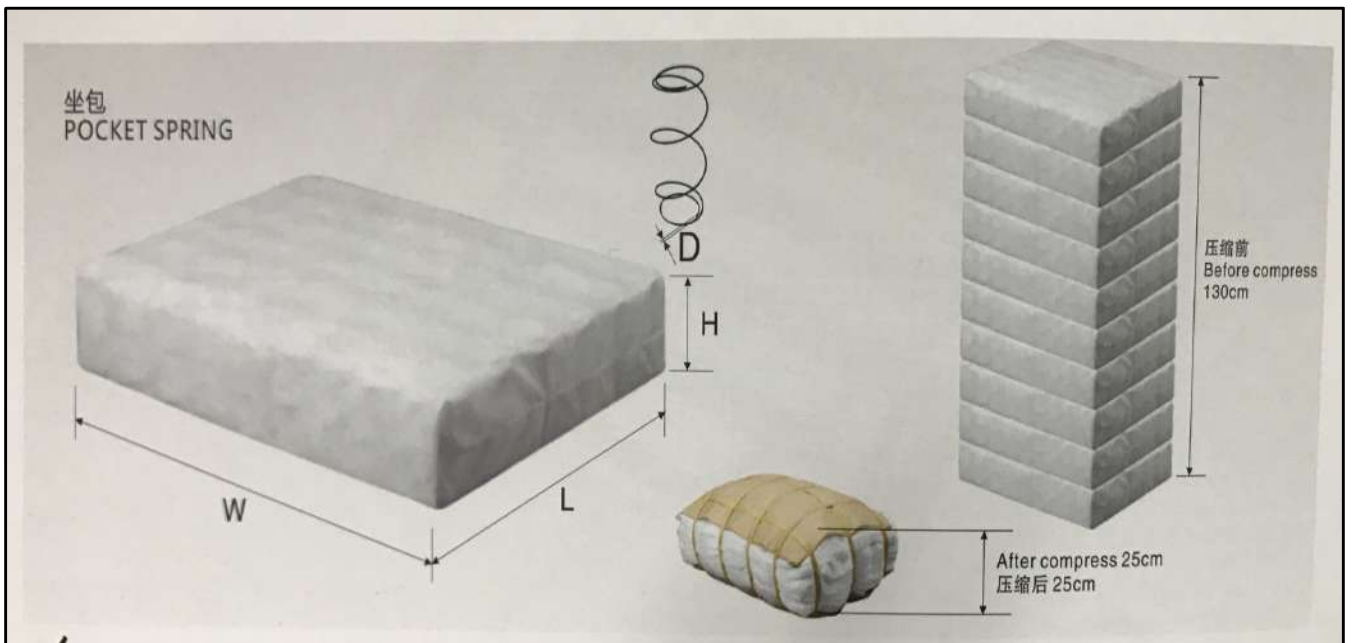

**POCKET SPRING (4"X41CMX46CM)(16"X18") (1PAC X 15PCS)**

**POCKET SPRING (3"X41CMX46CM)(16"X 18") (1PAC X 15PCS)**

**100 % VIRGIN 15D X 64MM Polyester Staple Fiber**  
- Siliconized  
- Hollow Conjugated



**100 % RECYCLED 15 D X 64MM Polyester Staple Fiber**  
- Siliconized  
- Hollow Conjugated





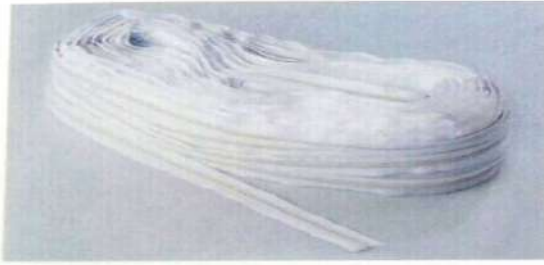

**5# Zipper White**

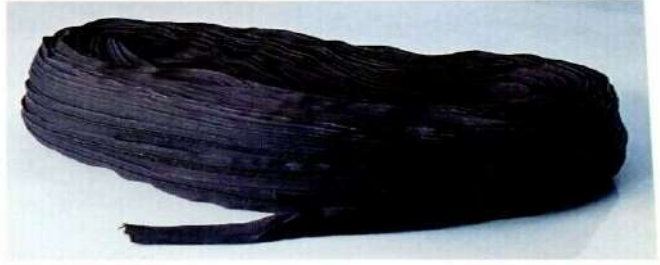

**3# & 5# Zipper Black**

100 M / PACK



**3# & 5# Slider Black**

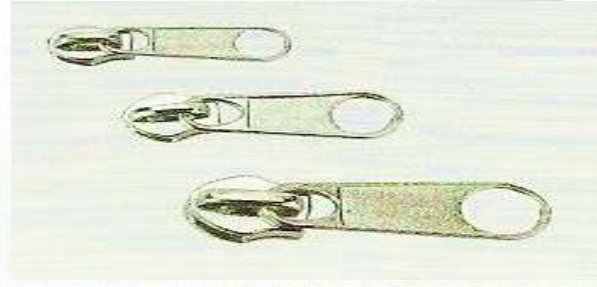

**5# Slider**

1000 PCS / PACK

**LACE (10 mm)**



SOFA LACE 368 (1R X 50M)



SOFA LACE 268 (1P X 50M)/(1P X 42M)





**Cool Woven (酷布)**  
**Width: 63" , 35kg+/-/roll**  
**100GM/110GM**



**Foam Hole Cutter**  
**(海绵开孔器)**

- Diameter:**
- 20 mm
  - 22 mm
  - 25 mm
  - 28 mm
  - 30 mm



**Magic Fabric (魔术布)**  
**Colour: Black**  
**Weight: 100gm/ 160gm**



**PONGEE COLOUR**



**Pongee Cloth (Black)**  
**拉布 (黑)**

**Pongee Cloth (White)**  
**拉布 (白)**

**1ROLL X 300M**

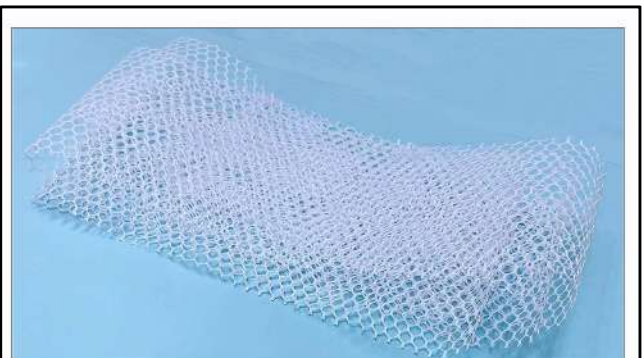

**Mesh Fabric (White)**  
**网布 (白色)**

**1ROLL X 60M**  
**Width: 2.0m**



**72"/86" Transparent Sheet T : 0.045mm**

**(1RX 200M)**



**Packaging Plastics  
(包装袋)  
72" / 86"**



**Paper Roll  
(51" X 30 KG)**

**OPP TAPE**



**OPP TAPE-96 ROLL/CTN**



**Opp Tape Dispenser**



**Stretch film  
H: 20" (50cm)  
Net Weight: 2.35kg/roll**

**6 ROLL/CTN**





**F75 Spray Gun ( Iron kettle )**  
**(F75 喷枪 (铁壶) )**



**SPRAY GLUE 828 & 338 (13KG)**



**棉绳 (普白)**  
**White Cotton String**  
**Diameter: 4mm , 5mm**

**1 PACK X 9 ROLL X 4 KGS**



**Velcro Tape**  
**粘扣带**

**Black**  
**25mm, 50mm, 100mm**

**White**  
**25mm, 50mm**

**25MM > 40ROLL X 25MTR = 1000MTR/CTN**  
**50MM > 20ROLL X 25MTR = 500MTR/CTN**  
**100MM > 10ROLL X 25MTR = 250MTR/CTN**

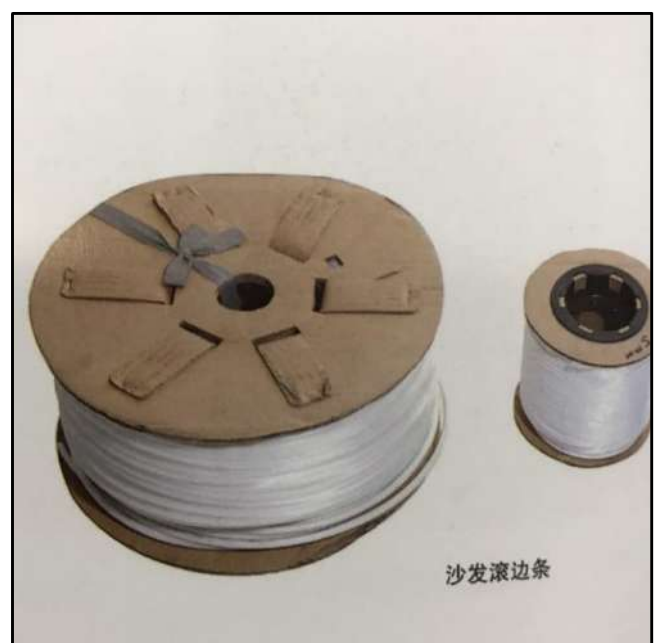

**PVC STRING – 4mm 1CTN X 4R X 800M**

沙发滚边条



**CHIPBOARD 700GM X 31"X 43"**

700 GM ( 1 PAC X 50PCS)



**DJ 026 Rack (齿条)**

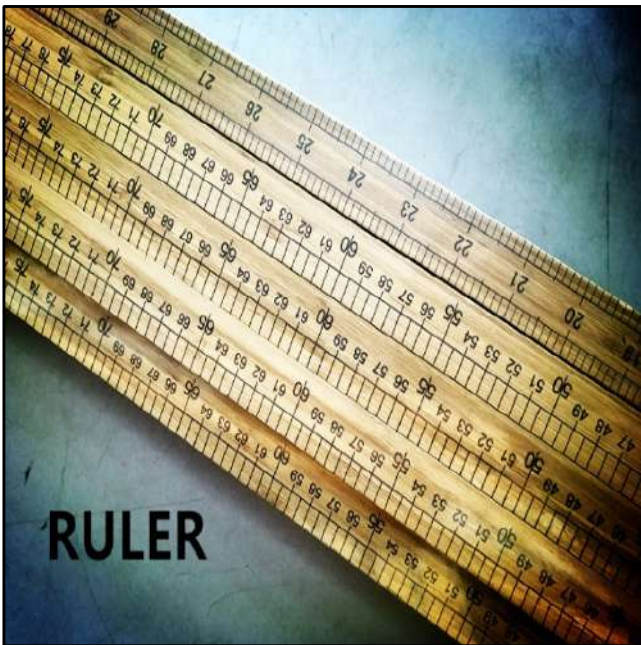

**RULER**



**SCISSORS - 10, 11" 12"**





**BUTTON 28**

**BUTTON 32**

**BUTTON 36**

**1000 SET/PACK**



**Button Mould**  
**包钮模具**  
**Size: 28, 32 & 36**

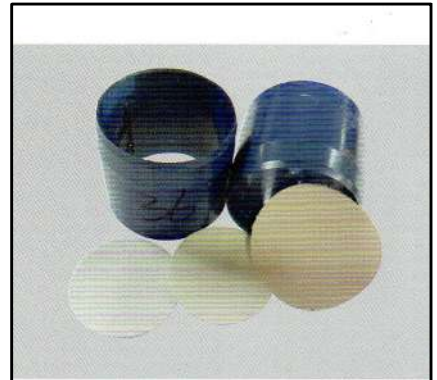

**Cutting Mould**  
**包钮刀模**  
**Size: 32 & 36**

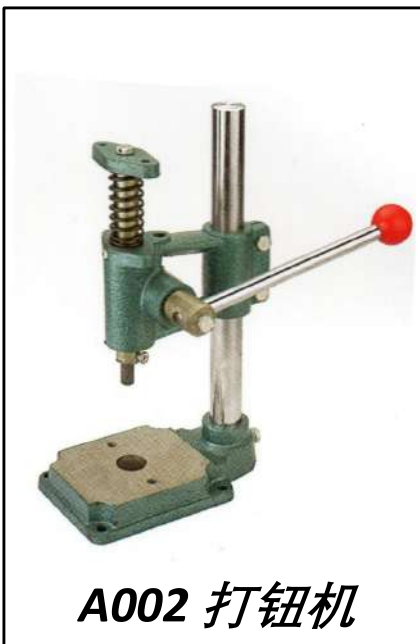

**A002 打钮机**

**MANUAL COVERING  
BUTTON MACHINE**



**A013 踏脚式气  
动打钮机**

**PNEUMATIC COVERING  
BUTTON MACHINE**



**A016 手动冲皮机**

**MANUAL BUTTON  
CUTTING MACHINE**



**Electric Circle Scissors -  
70mm**



**Electric Circle Scissors-  
100mm**

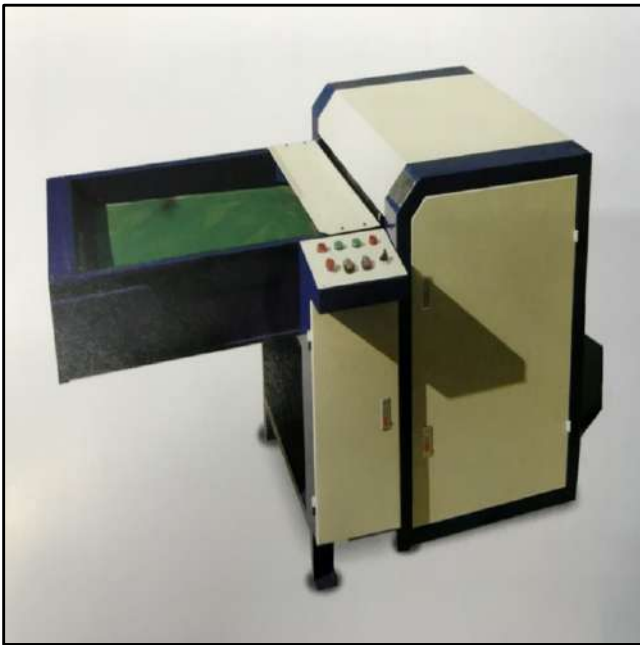

**FIBRE CARDING MACHINE AV-909**



**MIXING MACHINE AV-901**



**BLOWER**



**FIBRE FILLING MACHINE AV-905B**



AV-501/502

**FOAM SHREDDER**



**HOT  
AIR  
MACHINE**





**C钩钳**  
**C HOOK PLIERS**



**Eyelet 28 Mould**



**C HOOK RING 1CTN X 30B X 700GRM**  
**C HOOK RING 1CTN X 4BOX X 4KGS**



**EYELET 28# (IRON,COPPER) 1000 SET / PACK**  
**EYELET 30# (COPPER) 500 SET / PACK**

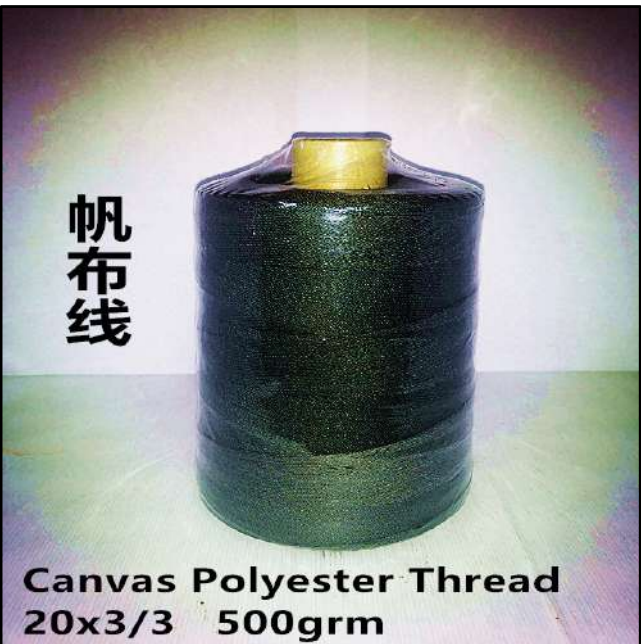

**帆布线**

**Canvas Polyester Thread**  
**20x3/3 500gm**



**SUN BUCKLE 1"**  
**IRON (1CTN X 8P X 500PCS)**  
**ALUMINIUM (1CTN X 10P X 500PCS)**



25 KG/PACK



25 KG/PACK



1R X 100M

